

ULTIMA[®]2



The Challenge

A true reference-caliber loudspeaker is a rarity in the world of music and cinema—its introduction an event that reverberates throughout the industry. And no company better understands this phenomenon than Revel. When its Ultima Series premiered in 1997, it was immediately lauded by the most discriminating reviewers and audiophiles as one of the world's best. Ultima has since been honored as a reference standard of uncompromising musicality, unbridled dynamism and fidelity to the recorded event.

Kevin Voecks | Director, Revel Products



Ultima's state-of-the-art music and cinema systems accurately capture the magic and raw emotion of the live performance as well as the pulse-quickenning excitement of a surround-sound movie soundtrack. Eight years later Revel's world-class engineering and design team faced an even greater challenge; how to surpass a legend? It would mean a reimagining of the current state of the art—a groundbreaking new concept.





Introducing the Ultima2 Series —the new summit in the art of loudspeaker design

A collection of four entirely new models—the Revel Salon2 and Revel Studio2 floor-standing loudspeakers, the Revel Gem2 on-wall or stand-mounted loudspeaker, and the Revel Voice2 center-channel loudspeaker. Ultima2 combines a dazzling visual aesthetic while affording unmatched flexibility for any style and configuration of listening space—from the modest den, to the high-flow family area, to the dedicated media room.

With the unparalleled resources of its parent company, Harman International, at its disposal, Ultima2 represents the most exhaustively researched and developed, critically evaluated and rigorously crafted products in Revel's ten year history. Setting new standards in accuracy, refinement and seat-of-the-pants excitement, the Ultima2 Series is nothing less than a celebration of Revel's passionate commitment to performance.



Vision Is Never Outsourced

From any point of view, the Ultima2 series is a feast for the eyes. Each sensuous line and arc the realization of form and function that not only flatters a listening area but elevates the listening experience to new heights. Available in either a shimmering high-gloss mahogany veneer or a high-gloss piano-black finish, Ultima2's true beauty is much more than skin deep.

A close-up, high-angle photograph of a speaker cabinet. The top portion of the image shows a smooth, dark, possibly black or dark grey, surface with a subtle sheen. A sharp, curved line separates this upper section from a lower section covered in a dark, textured fabric grille. The lighting is dramatic, highlighting the curves and textures against a dark background.

Beneath the clean elegant contours of the cabinet lies a robust, single-piece, nine-layer MDF construction. From the narrow sonically-optimized baffles to the complex radius-edge details, every curve is earned. The benefits include vanishingly low diffraction, exceptional dispersion characteristics and the smoothest possible response, both on- and off-axis. And the high-resolution analysis of laser interferometer scans insures that the cabinet is as inert as it is stunning. Even the speaker grilles have been uniquely attended to. They are easily removable for the most critical listening and are magnetically attached, leaving no unsightly hardware fittings to mar the exquisite finish.

A Company That Listens

From its inception ten years ago, Revel was a company designed from the ground up to pursue the ever-evolving state of the art in loudspeaker design and manufacturing. With the vast resources of its parent company, Harman International, at its disposal, innovation, craftsmanship and vision were not merely encouraged. In fact, they were expected. Against this challenging backdrop formed an international team of researchers, acousticians, acoustic system and mechanical engineers, all charged with the mission of developing nothing less than the world's finest loudspeakers.

Unlike some competitors, Revel's top-to-bottom in-house engineering team addressed every element of loudspeaker design. Revel rejected off-the-shelf transducers often "tweaked" for a modest gain in performance. Rather, all new transducers were designed from scratch with the assistance of powerful Computer Aided Design software and Finite Element Analysis. Working prototypes were exhaustively tested and retested by engineering equipment purpose-built to reveal the smallest flaws. While other companies might rely on anechoic simulations, which often fail to reveal performance flaws, Revel used actual anechoic chambers—in fact it proudly uses three of them. Tolerances were honed using a Stereo Lithography Apparatus (SLA). These results were evaluated and advanced manufacturing processes were subsequently developed to narrow tolerances to ever finer gradations. The mandate of unmatched unit-to-unit consistency was enforced with an inspired combination of high-tech and old-school—sophisticated test measurements, coupled with rigorous hand tuning for every loudspeaker produced.



True anechoic chambers provide accurate data that electronic simulation cannot match.



Yet these advancements were merely pieces in a much larger and more complex puzzle. The reference-quality performance for which Revel is renowned is due to much more than the sum of its component parts, its exquisite craftsmanship, or its relentless R&D. It was instinctively understood at Revel that test equipment can't begin to appreciate a symphonic score, the rhythm of reggae or the urban pulse of hip-hop. And for all its objective sophistication a computer cannot match the most sensitive component of all—the human ear. Yet, on the other hand, mere seat-of-the-pants listening impressions were also deemed far too subjective and inconsistent. A seemingly unbridgeable divide. But what if the principles of each discipline, objectivist and subjectivist, could be woven into a single body of thought, validated by rigorous and repeatable testing systems? Inspired Revel engineers hastened forth a new era of Musically Relevant Measurements. MRM was developed to actually correlate to sound quality. It created original listening tests and a suite of measurements that yielded data that didn't merely look good on a cold sheet of graph paper, but audibly translated into sound reproduction that more closely represented what we actually hear.

Revel's Multichannel Listening Lab (MLL) is a core example of the advanced listening techniques Revel's team has devised to provide an accurate correlation between objective laboratory measurements like those recorded in an anechoic chamber and "in-room" sonic performance like the average listener might experience at home. MLL represents the industry's most sophisticated listening facility, allowing trained panelists to compare speakers under genuine "double blind" conditions. Listening lab panelists aren't subjected to test tones and noise patterns. Rather, they listen to a variety of familiar music, able to repeat tracks as necessary while they tabulate their conclusions. Revel's tests are based on extensive real world listening to numerous different environments that simulate a wide range of residential settings and room sizes. Such a multifaceted process is just another factor that keeps Revel many sonic steps ahead of its competition. Nothing, however, can prepare the discriminating listener for the full Ultima2 experience. Regardless of orientation—from the traditional two-channel audiophile, to the dedicated surround sound cineaste or the high resolution multichannel maven, there's a Revel Ultima2 series system designed to exceed every expectation.



Detail of the Multichannel Listening Lab (MLL) with the acoustically transparent curtain opened to reveal the speaker-switching stage—a computer controlled platform and pneumatic conveyor system that can exchange speakers and reposition them in precisely the same location in just a few seconds. All tests are conducted "double blind" so that no one is aware of the identity of the changing speakers.

Experience a Revelation: Ultima2 by Revel

Taking the Edge off Diffraction

Diffraction results when the radiated wave from a transducer strikes what is often a sharp edge at the front of its enclosure. The result is a secondary diffractive wave that reaches the listener delayed in time—a delay that results in an adverse effect on frequency response. The impact is audible and can be experienced as degraded timbre, a lack of image focus and an incoherent soundstage. Revel engineers researched a myriad of alternative shapes that would virtually eliminate diffraction effects. Its findings, as beautiful as they are scientifically sound, have been realized in the Ultima2 series.

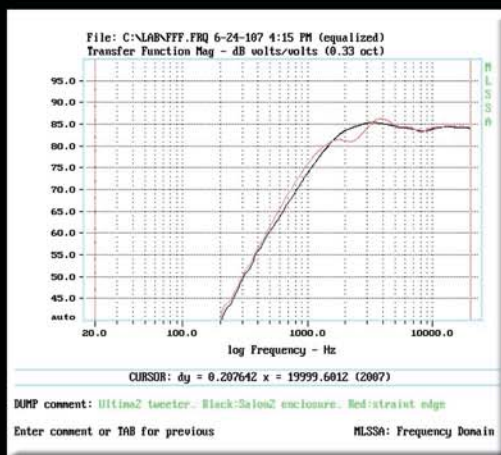
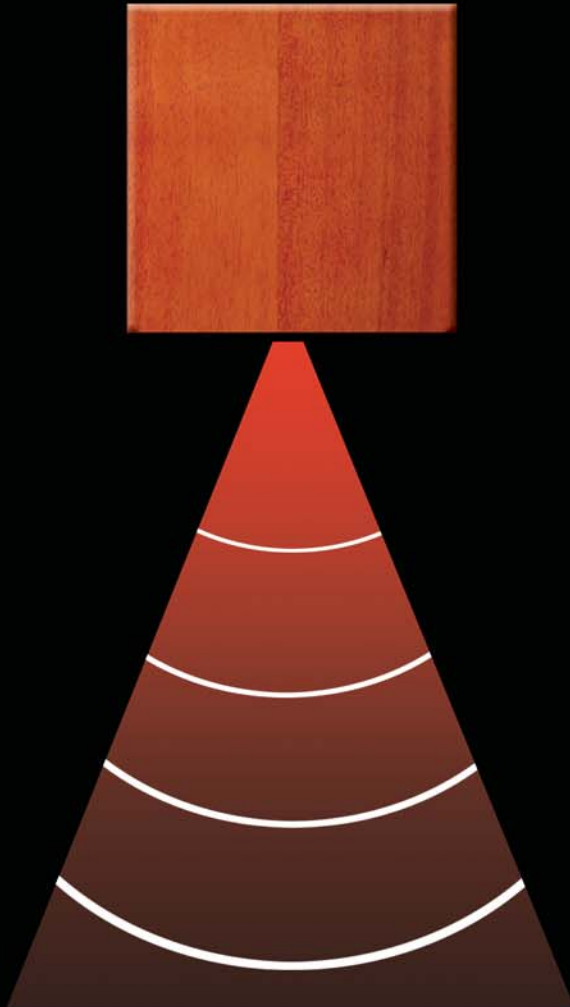

On-axis response of a Salon2 enclosure (black trace) compared to a conventional enclosure (red trace), indicate the profound influence of Ultima2's optimized baffle and enclosure.

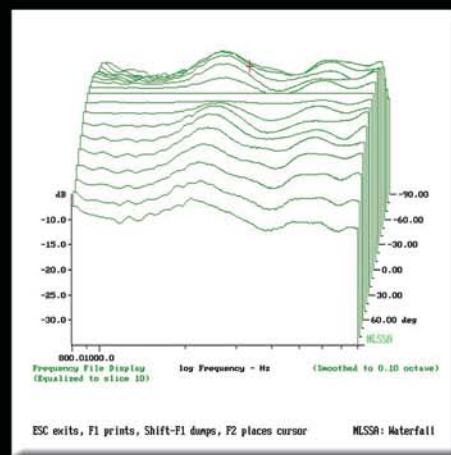

A conventional square-edged speaker. Note how the off-axis curves for the square-edged speaker are rough with response anomalies as illustrated by the jagged series of response lines. Ultima2 exhibits extraordinarily smooth, controlled off-axis response.

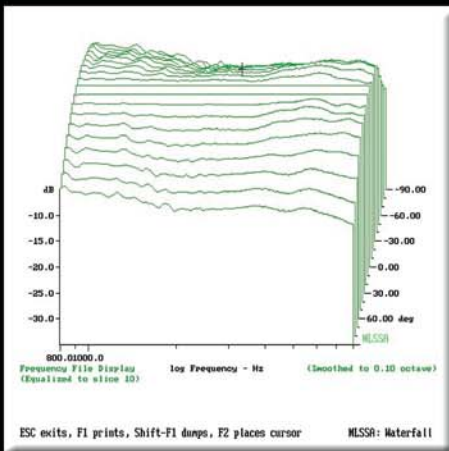
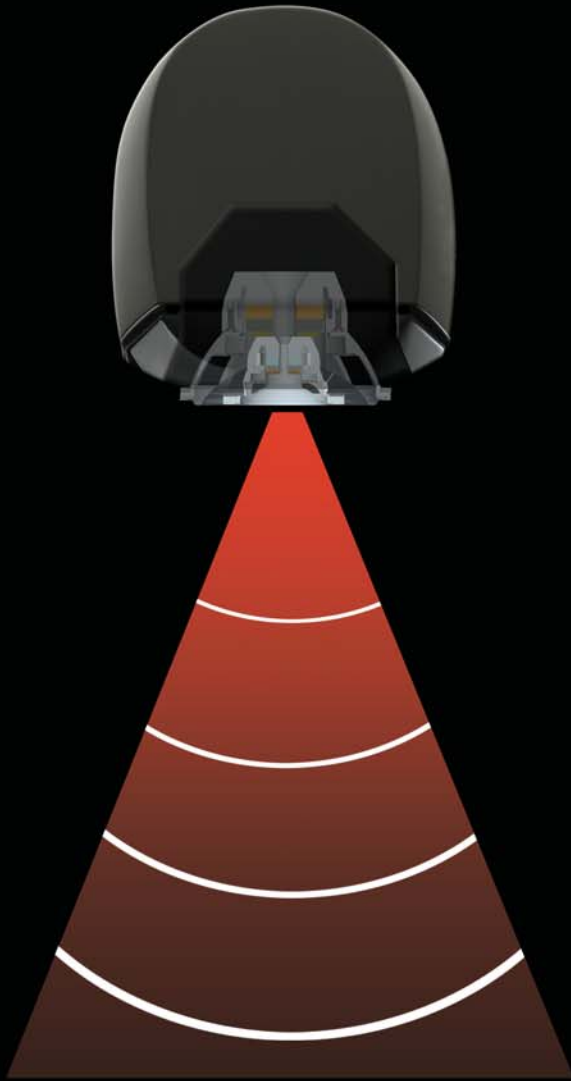

Contrasting “waterfall” curves demonstrate the anti-diffraction benefits of Ultima2 baffle and enclosure technology.

At the very heart

of the Ultima2 series is a completely new family of transducers designed exclusively by the Revel team for the Ultima2 series. Created to give full voice to music's every expression, Ultima2 drivers represent the current nexus of science and art. Conceived using state-of-the-art Computer Aided Design software (CAD) and Finite Element Analysis (FEA), the seven unique drivers in the Ultima2 Series reside at the summit of current transducer technology. Whether it's the splash of a cymbal, the upper register of a Steinway or the final note of an aria, Ultima2's exotic new 1-inch tweeter is a sonic wonder and a technological *tour-de-force*. It sports a pure beryllium dome and Revel's third-generation waveguide for astounding dispersion. Shared by the entire family of Ultima2 loudspeakers, it bests its predecessor with an even higher output capability and lower dynamic compression, setting new Revel standards for breathtaking transparency and low coloration. Not to be overshadowed is the all new collection of Ultima2 woofer and midrange

transducers which feature inverted-dome designs and titanium diaphragms—a material noted for its very high tensile strength. The unique geometry of Ultima2's inverted domes delivers superb piston-like behavior even at maximum sound levels. Oversized voice coils wound with flat copper "ribbon" wire assure remarkable high output capability and the lowest possible dynamic compression. The ribbon-wire voice coils also exhibit superior heat transfer and improved efficiency. The inverted, dual neodymium magnet motor configuration combines sheer power with excellent magnetic shielding and efficient packaging. An array of sophisticated distortion reduction mechanisms has also been incorporated and includes an aluminum flux stabilization ring and, in specific units, a conductive copper ring—innovations that audibly reduce second and third order harmonic distortions. Collectively these innovations represent the pinnacle in transducer design and a dramatic improvement in sonic performance from the original Ultima Series.

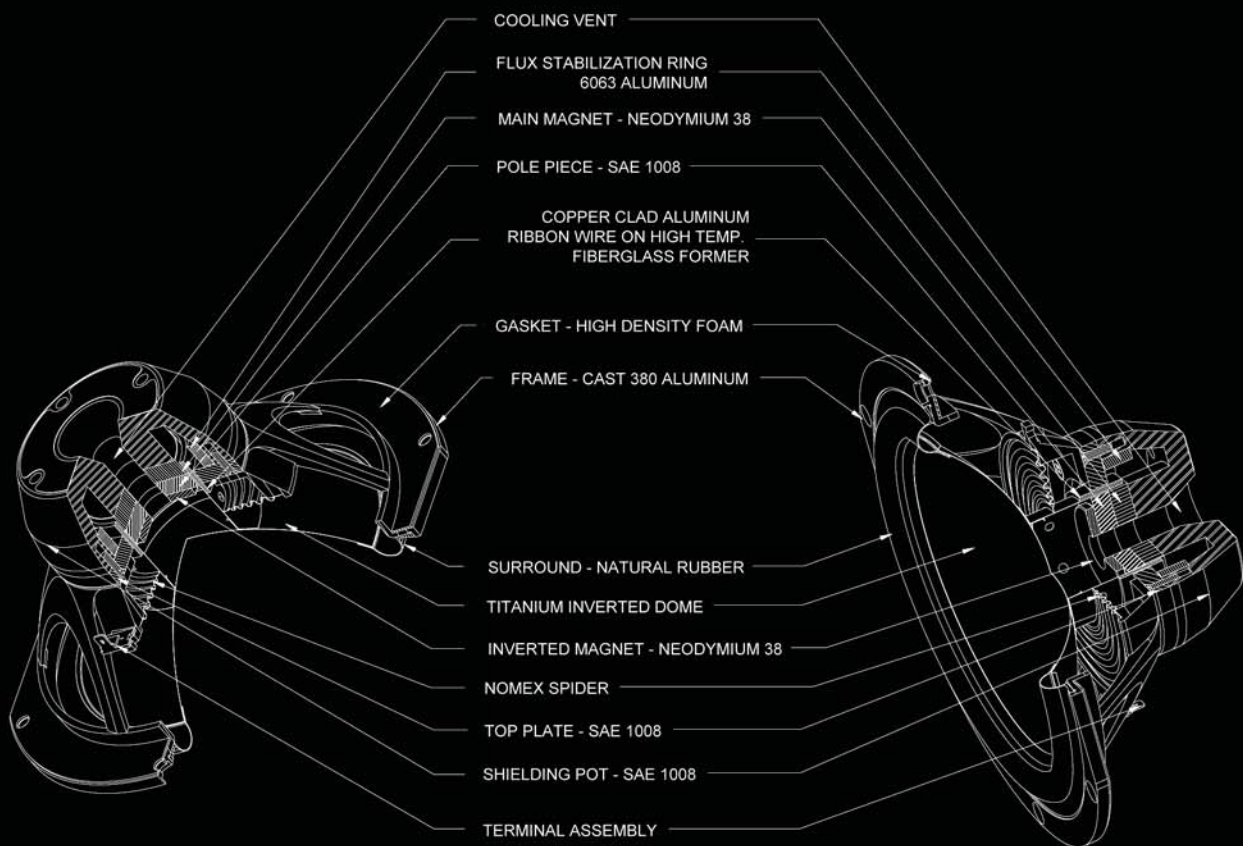





Diamond is Nice but Beryllium is a Tweeter's Best Friend

The evolution of tweeter domes over the decades is a story of increasingly more exotic materials—and wider performance envelopes. The latest examples are chemical vapor deposition diamond and beryllium. In every case, however, there are three constants regarding tweeter dome material performance. They are velocity of sound, density and Poisson's Ratio.

The pure beryllium dome tweeter used in every Ultima2 loudspeaker exhibits a formidable balance of these properties that is difficult to match. Beryllium's density is by far the lowest in the group,

half that of diamond. This minimizes compression and reduces distortion. Its velocity, as measured in speed of sound, is second only to diamond although break-up is still beyond 50 kHz, and its Poisson ratio, a key yardstick of material elasticity appropriate for audio, is much lower than even diamond. Taken collectively these results confirm why Ultima2 beryllium tweeters exhibit behavior that's long on extension, low on distortion and dynamic compression and economical on power handling. The conclusion is inescapable. Diamonds are hard to beat in an engagement ring, but beryllium was made for music.

Material	Density g/cc	Velocity of Sound m/s	Poisson's Ratio
Aluminum	2.7	5000	0.33
BeAl	2.1	10000	0.14
Beryllium	1.8	13000	0.08
CVD Diamond	3.5	16200	0.31
Magnesium	1.8	4900	0.35
Titanium	4.4	5200	0.30



Laser interferometer scanning a transducer diaphragm

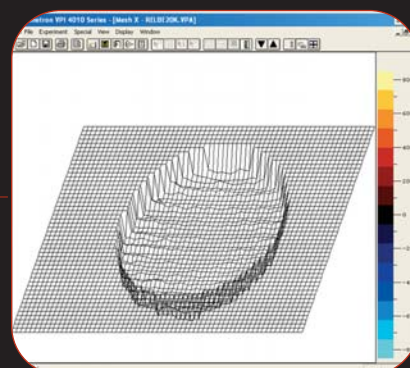
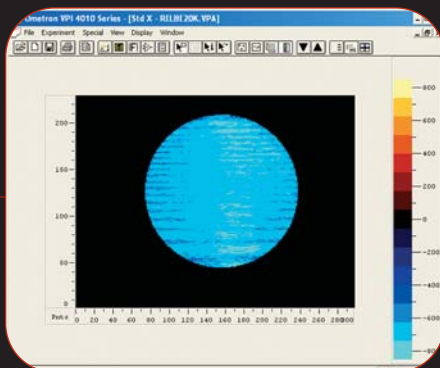

Results of laser interferometer scans indicating piston-perfect behavior at 20 kHz

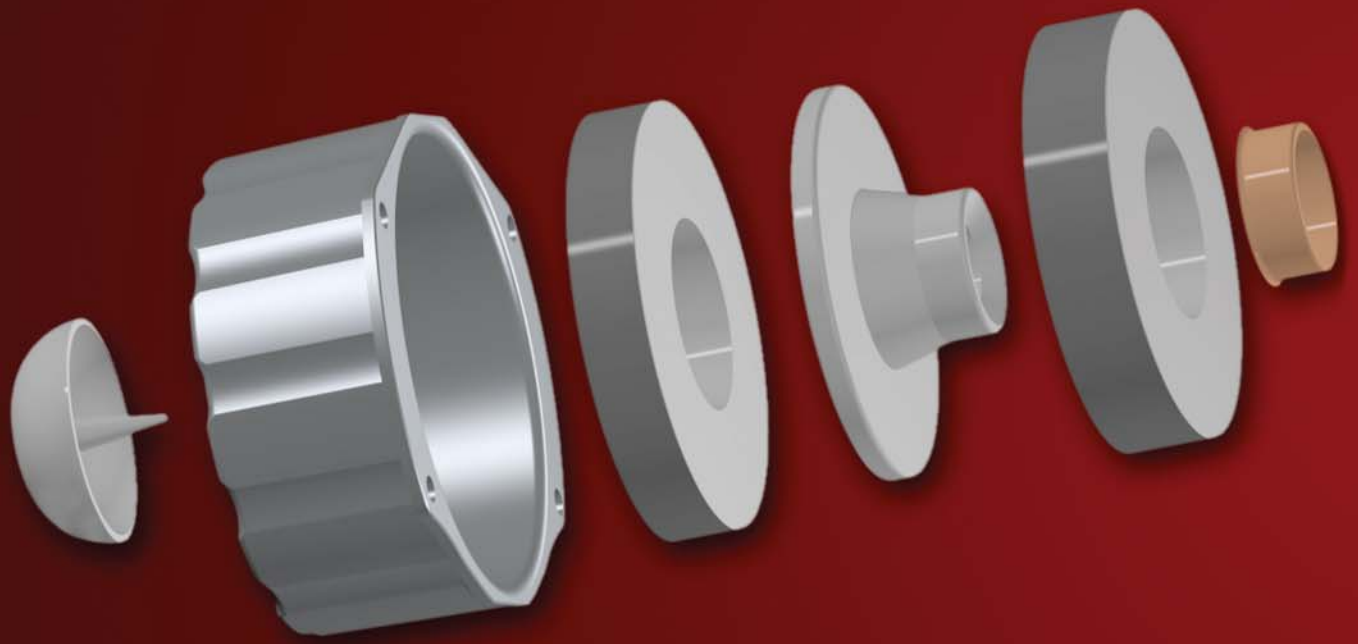



High-Performance-Driven Motors

The motor technology in every Ultima2 tweeter involves electromagnetic principles of profound complexity. For Revel engineers, however, the ultimate goal remains a deceptively simple and unchanging one—a stunning listening experience free of audible distortions and colorations. To do this they have implemented oversize main and bucking magnets. The steel around the air gap is thoroughly saturated, a practice that significantly reduces the variation of the magnetic field caused by nonlinearities in steel. Odd-order harmonic distortions, highly audible to the human ear, have been effectively trumped. Additionally, a copper cap on the pole piece (magnetic gap area) further

attenuates these artifacts, even as it reduces inductance modulation. Assuring a tweeter's accurate response at the crossover point means keeping its mechanical resonance well below the operating band. Ultima2 incorporates a large air vent on the pole piece and a compliant diaphragm surround to reduce the resonance frequency below 600 Hz. Secondary resonances are damped with an irregular shape. Also, a unique pin at the back of the rear cavity further breaks up standing waves and resonances. The addition of acoustic damping in the cavity completely eliminates secondary resonances, thus improving frequency response.

Catching the New Wave in Waveguides

Because the diameter of a tweeter and a midrange driver differ greatly in size, directivity inconsistencies can be a significant issue. Tweeter waveguides are a common solution, but directivity above 9 kHz has remained a challenge. It took the uncommon resourcefulness of the Revel team to develop a new generation of slender waveguides for Ultima2. Careful engineering of the conical section of the waveguide and the delicate transition details at the waveguide's entrance and exit have resulted in tweeter directivity that is seamlessly matched in the crossover region to the midrange driver. Other key benefits include superb high-frequency dispersion above 9 kHz, the flexibility to lower the crossover point due to an increase in gain of between 3-7 dB in the crossover region, and improved power handling with lower compression.



Crossover networks

are often referred to as the “unsung heroes” of loudspeaker design, but their contribution is no less significant. Throughout the Ultima2 family, separate filter boards are used for each frequency range to provide freedom from magnetic interference, a source of distortion. Air-core inductors are used throughout, as is point-to-point wiring and ultra-high-purity copper wiring from crossover to the transducers. What’s more important, the design of Revel crossover networks is unmatched. Sophisticated Computer Aided Design (CAD) software is utilized with state-of-the-art measurements and controlled listening tests to achieve superb integration, transparency and musicality.



Response curves indicating the exemplary acoustic output of each filter network section with its associated transducers in a Salon2 loudspeaker

Tuned to Perfection

In preparation for final assembly, an exclusive “tuning” process is used to performance match each and every Ultima2 series loudspeaker within a fraction of a decibel to the original laboratory prototype. All tuning adjustments and specifications are recorded, referenced to the speaker’s serial number and retained for archive purposes. Owners can rest assured that their Revel Ultima2 loudspeakers sound as great as the lab reference and the reviewer’s samples.

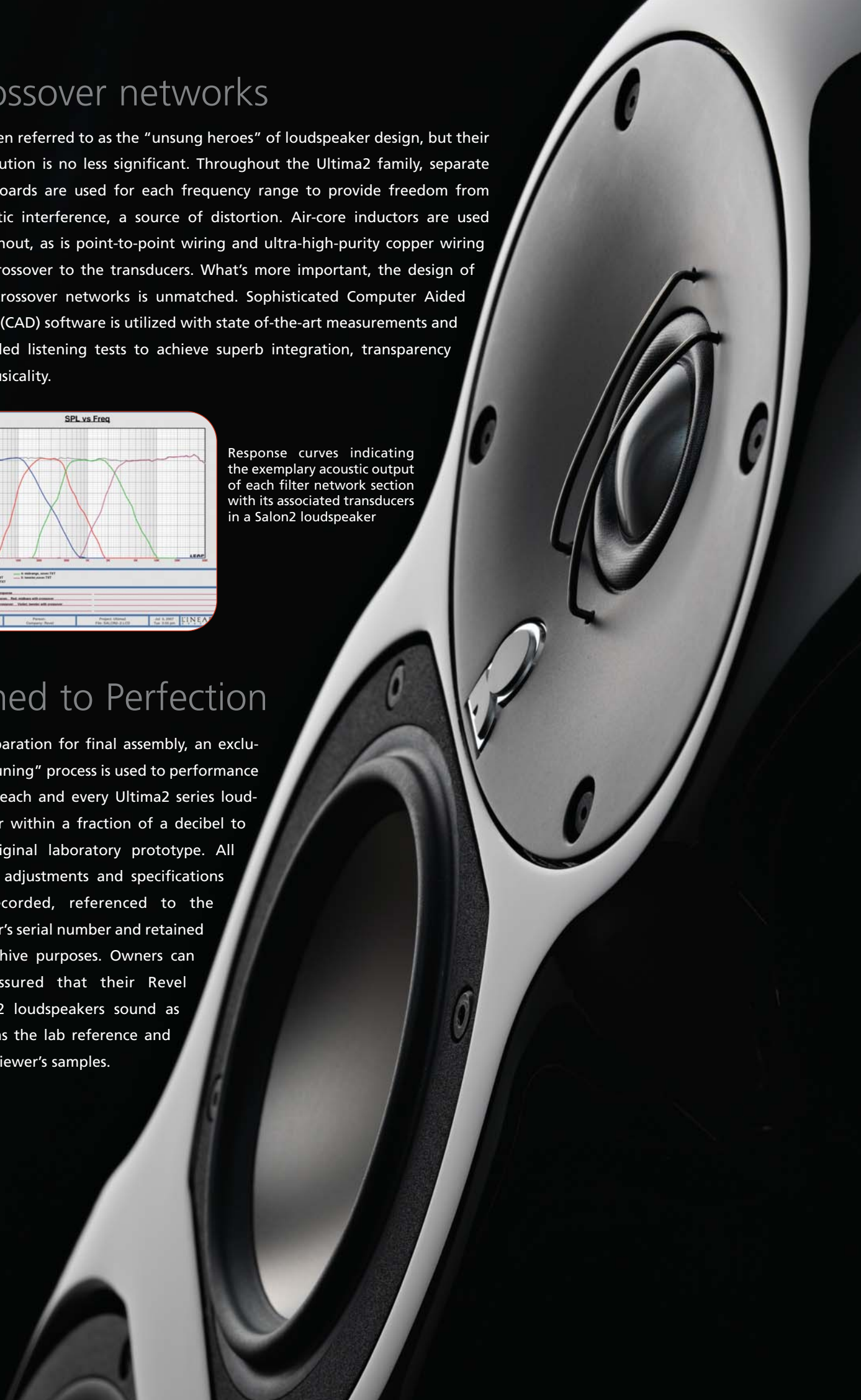

SALON²



STUDIO²





Ultima Salon2 and Studio2 are the most visionary speaker systems that the Revel team has ever produced.

Strikingly designed and crafted to exceed the demands of the most challenging installations and tastes, Salon2, and the less imposing Studio2, radiate an elegance and authority that can only be matched by their reference-standard sound quality. Imbued with the Revel philosophy that there is no separation between art and accuracy, the new Salon2 and Studio2 do not editorialize sound reproduction; rather, they celebrate the full expression and soul of the actual musical event.

Ultima Salon2 or Studio2, Revel's reinterpretation of the classic floorstander is a *tour-de-force* of craftsmanship and features the full panoply of Revel's cutting edge technological innovations and enhancements. Among them are the entirely new family of transducers designed by the Revel Engineering team exclusively for the Ultima2 Series. Utilizing state-of-the-art Computer Aided Design software (CAD) and Finite Element Analysis (FEA), the Salon2 and Studio2 woofer and midrange drive units feature dual neodymium magnet motor systems with sophisticated distortion-reduction mechanisms, titanium diaphragms

and oversized voice coils wound with ribbon wire. The new 1-inch dome tweeter is fashioned of pure beryllium and integrates third-generation waveguide technology for improved dispersion. Its advanced magnetic assembly incorporates a copper cap for lowering distortion, while the large-vent pole piece and self-enclosed chamber drives the mechanical resonance well below the crossover frequency. Additionally, an enhanced damping system eliminates secondary internal resonances commonly found in vented tweeters. It bests even its predecessor with enhanced output capability and lower dynamic compression.



Awe inspiring would have to be part of any general description of the Salon2 and Studio2.

The Salon2 is built around a six-driver array in a four-way, vented system configuration. The transducers include three 8-inch woofers, a 6 1/2-inch mid-woofer, 4-inch midrange and 1-inch tweeter.

The Studio2 adopts a similar approach but in a more discreet physical package. It is a three-way system utilizing two 8-inch woofers, a 5 1/4-inch midrange and a 1-inch tweeter, and is ideal for applications that don't require the massive output and bottom-octave footprint of the Salon2.

In both instances the multiple woofer arrays in Salon2 and Studio2 offer a fundamental advantage over the more traditional "big" woofer approach without sacrificing a decibel of bass foundation. The smaller cone diameters permit a narrower cabinet waistline, critical for managing diffraction artifacts. The result is pristinely focused imaging and as wide a soundstage as the recording will permit. Bass extension is likewise preserved by virtue of the robust collective output of the multiple woofers. For example, the three 8-inch woofers of a single Salon2 displace almost the equivalent diaphragm area of a single 14-inch woofer. Similarly the total area of the twin 8-inch woofers of a single Studio2 is actually greater than an 11-inch woofer. Who said you can't have your cake and eat it too?



Bending Technology with a Flare

Loudspeaker porting is a well regarded method of augmenting low frequency acoustic output while preserving the speaker's overall efficiency. However, when output is increased beyond the point where the air in the port is able to respond in a linear fashion, the port begins to generate extraneous noises, acoustic compression and distortion artifacts better known to audiophiles as "chuffing" or "overhang".

In recent years, rounding the ends of the port have helped to reduce some of these colorations. However, the latest research has found even greater performance gains can be realized by selecting a more aerodynamic profile along the length of the port and further fine tuning the flare at the port's exit and entrance. Naturally, Ultima2 features the latest generation of hyperbolic flare designs.

Another illustration of Revel's commitment to the principle that the only sound worth hearing is from the recording itself.

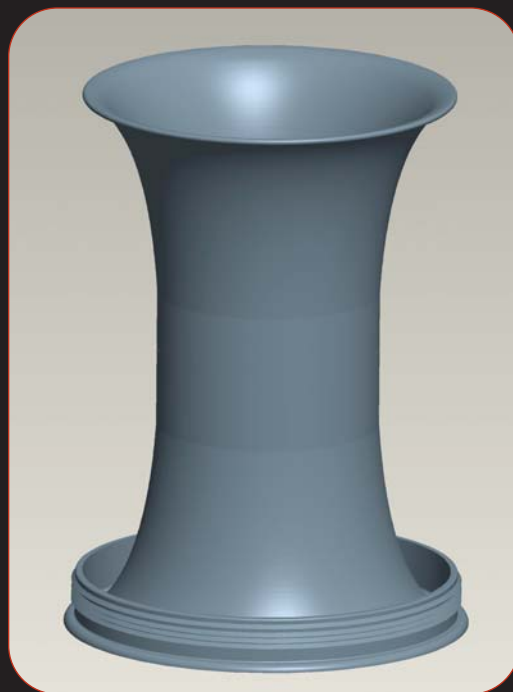

Experience a Revelation: Salon2 and Studio2 from Revel

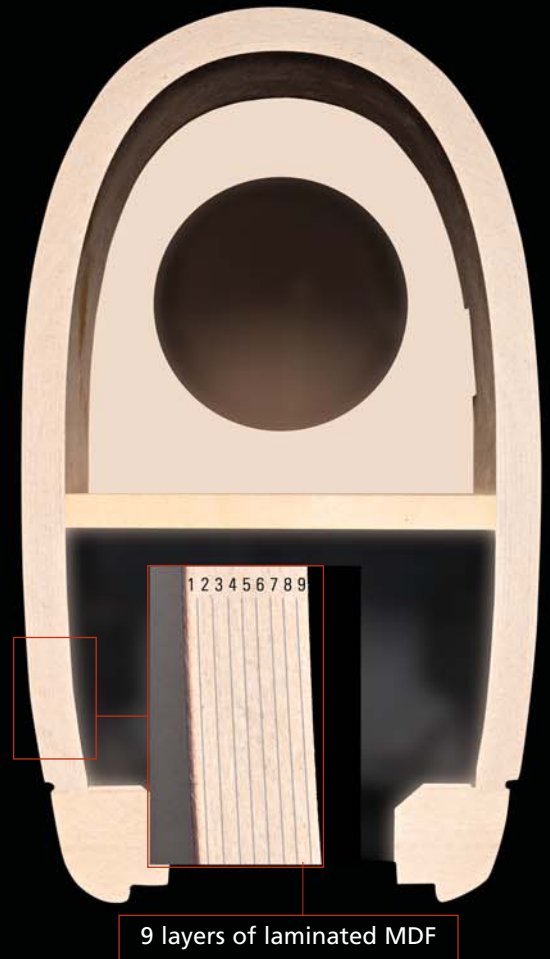
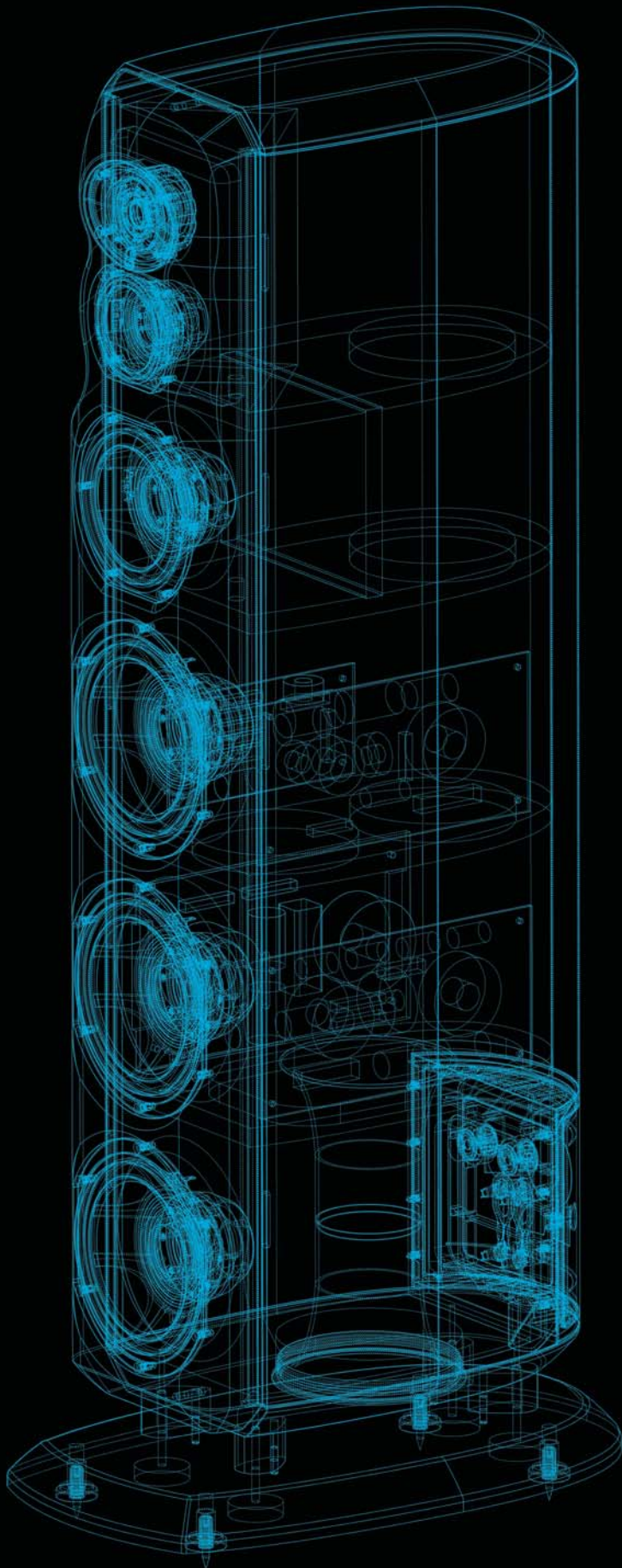

Salon2 and Studio2 cabinet construction is of necessity robust and innovative—in the extreme. Rather than pursuing traditional flat-panel cabinetry with old fashioned corner joints, Revel has opted for a curvilinear single piece enclosure—nine layers of laminated MDF in all—which completely eliminates two joints . The exterior structure is then further reinforced by sophisticated and massive interior bracing. The result is a cabinet that's exceptionally inert and free of audible colorations. Further enhanced with a sonically optimized 2-1/2 inch thick baffle and an opulent high gloss “concert” cabinet finish, Salon2 and Studio2 are as delightful for the discriminating eye as they are satisfying for the refined ear.

Like all Revel Ultima2 loudspeakers, the Salon2 and Studio2 also offer adjustments to optimize their response to the specific application and room acoustics both at low and high frequencies. Unlike most other so-called "adjustable" loudspeakers the hand-tuned crossovers remain perfectly calibrated when the precision controls are adjusted assuring

superb imaging regardless of the control settings. Further evidence of Revel's painstaking attention to detail is the manner in which this cast-aluminum control and input panel is ingeniously hidden from view behind a smoked access cover, which is itself a continuation of the elegant shape of the cabinet.



Finally, Revel understands that the acquisition of a Salon2, a Studio2 or any speaker system in the Ultima2 family amounts to a serious and long-term commitment. This is why Ultima2 systems are built to the highest possible standards available. By offering this unparalleled level of performance, owners can rest assured that an Ultima2 purchase will provide them pleasurable listening for many years to come.



Experience a Revelation: Salon2 and Studio2 from Revel



Normal Contour Boundary

Low Frequency Compensation



-1 -5 0 +5 +1
Tweeter Level
(dB)

GEM²

The Gem2 is, as the name implies, a design with a multifaceted nature. Optimized for a range of applications and equipped to face any room placement, it's versatile in the extreme yet sonically uncompromising. For example, the Gem2 can be used as a high-quality front loudspeaker, either on available pedestals or wall-mounted using the included bracket. In two-channel or multi-channel applications, the Gem2 is the loudspeaker for solutions. And thanks to their low profile wall-mounting, the Gem2 makes them especially attractive for use with the wide range of state-of-the-art flat-panel televisions.



The Gem2 is equally optimized for use as a surround loudspeaker, offering ideal timbre matching with other Revel Ultima2 series loudspeakers for a seamless and immersive multichannel performance. Whether the respective owner is inclined towards intimate stereo listening or wants to employ Gem2 in a sophisticated side- and back-channel ultimate Ultima2 array, Gem2 will exceed all expectations. And since Gem2 is built to the same exacting standards of the entire Ultima2 family, you can be confident that any combination of mixing and matching will yield the same rich tonal balance and timbre-matched dispersion characteristics for which Revel Ultima2 loudspeakers are renowned.

Experience a Revelation: Ultima Gem2 from Revel



Although the Gem2 loudspeakers are physically compact, the robust 3-way design delivers a one-two punch of reference-caliber tonal accuracy and astonishing output. Utilizing the latest transducer technology developed exclusively for the Ultima2 family, Gem2 offers an 8-inch woofer with an oversize 2-inch voice coil and a 4-inch midrange with a similarly-oversize 1 1/2-inch voice coil. These drivers incorporate sophisticated double neodymium magnet assemblies and are wound with ribbon wire to provide performance of breathtaking output, rich timbre and tonal accuracy with both extraordinarily low dynamic compression and freedom from distortion. Revel's breathtaking new pure beryllium tweeter provides pristine clarity to deliver an unequalled listening experience.







VOICE²

In a multichannel system, no single speaker is charged with a more important mission than the center channel. Often carrying as much as 75% of a modern cinema soundtrack at any one instant, the center channel is the acoustical anchor for the entire system. Which is why Revel created the Voice2 loudspeaker. Built with the same exacting standards for tonal accuracy resident in every Ultima2, the Voice2 enjoys an effortless command of dynamic contrasts, textural detail and resolving power. And its unflagging output permits it to articulate every musical crescendo and blockbuster special effect that comprise today's multichannel and surround-sound experience. Drawn from

Revel's remarkable new family of Ultima2 transducers, Voice2 sports a pair of 8-inch woofers, and a 5 1/4-inch midrange and huge 2-inch diameter flat-wire voice coils. Voice2 offers not only an extraordinarily wide dynamic range, but the luxury of compression-free performance. Add the pristine resolution of the pure beryllium 1-inch Ultima2 series dome tweeter and computer-optimized high-order filter networks, and the Revel Ultima Voice2 will reproduce the softest utterance or the loudest concussion. By any standard Voice2 provides an elevated sonic experience at the most demanding output levels.



The Revel Ultima Voice2 Loudspeaker extends flexibility to a whole new level. Beyond its primary intended use as a center channel partnering with other Ultima2 Series loudspeakers, Voice2 is ideally suited as a "three-across" loudspeaker (or LCR, left, center, and right front positions). Its appealing size is tailor-made for home-theater applications requiring above- or below-the-screen placement. However, in any configuration owners can be assured that the Voice2 will accurately reproduce the rich timbre and tonal balance of the entire Ultima2 family and create the immersive sound experience that multichannel and home-

cinema systems often pursue, but rarely capture. Since Revel understands that no two listening rooms respond identically, rear panel controls are thoughtfully provided to compensate for Voice2 placement on their available stands, or when built-into custom cabinetry. Even when confronted with the most unusual acoustic challenges, correct timbral balance and tonality is preserved. Whether configured in stereo, LCR, or center channel only in a 5.1 or 7.1-channel system, the rigorous engineering poured into every Ultima2 loudspeaker ensures that your system will always speak with one and only one voice.

Experience a Revelation: Ultima Voice2 from Revel





SALON²

Specifications

Sensitivity	86.4 dB SPL with 2.83 V @ 1m (4 pi anechoic)
Impedance	6 ohms (nominal) 3.7 ohms (minimum @ 90 Hz)
Filter Network	Four-way, high-order acoustic response @150 Hz, 575 Hz, and 2.3 kHz
Frequency Range	- 3 dB from 23 Hz to 45 kHz
In-Room Response	±0.5 dB from 29 Hz to 18 kHz
Relative-to-Target Response	
Listening-Window Response	±1.0 dB from 26 Hz to 20 kHz
Low-Frequency Extension	-10 dB at 17 Hz -6 dB at 20 Hz -3 dB at 23 Hz
Dimensions & Weight:	
Loudspeaker Body	Width 11 inches (279 mm) Depth 18.8 inches (477 mm)
Loudspeaker (with non-removable base)	Height 53.25 inches (1353 mm) Width 14 inches (356 mm) Depth 23 inches (584 mm)
Shipping Weight	178 pounds (80.7 kg)



STUDIO2

Specifications

Sensitivity	87.7 dB SPL with 2.83 V @ 1m (4 pi anechoic)
Impedance	6 ohms (nominal) 3.7 ohms (minimum @ 90 Hz)
Filter Network	Three-way, high-order acoustic response @ 230 Hz and 2 kHz
Frequency Range	-3 dB from 32 Hz to 45 kHz
In-Room Response	±0.5 dB from 31 Hz to 18 kHz
Relative-to-Target Response	
Listening-Window Response	±1.0 dB from 33 Hz to 20 kHz
Low-Frequency Extension	-10 dB at 21 Hz -6 dB at 25 Hz -3 dB at 32 Hz
Dimensions & Weight:	
Loudspeaker Body	Width 10.75 inches (273 mm) Depth 16.6 inches (422 mm)
Loudspeaker (with non-removable base)	Height 46.25 inches (1175 mm) Width 13.75 inches (349 mm) Depth 20.5 inches (521 mm)
Shipping Weight	140 pounds (63.5 kg)



VOICE² | Specifications

Sensitivity	89 dB SPL with 2.83 V @ 1m (4 pi anechoic)
Impedance	6 ohms (nominal) 3.6 ohms (minimum @ 90 Hz)
Filter Network	Three-way, high-order acoustic response @ 235 Hz and 2 kHz
Frequency Range	-3 dB from 60 Hz to 45 kHz
In-Room Response	±0.5 dB from 65 Hz to 18 kHz
Relative-to-Target Response	
Listening-Window Response	±1.0 dB from 65 Hz to 20 kHz
Low-Frequency Extension	-10 dB at 36 Hz -6 dB at 49 Hz -3 dB at 60 Hz
Dimensions & Weight:	
Loudspeaker	Height 14.7 inches (373 mm) Width 25.5 inches (648 mm) Depth 14 inches (356 mm)
On Floor Pedestal	Height 24.2 inches (614 mm)
Shipping Weight	74.5 pounds (33.8 kg)



GEM 2 | Specifications

Sensitivity 86.4 dB SPL with 2.83 V @ 1m (4 pi anechoic)

Impedance 6 ohms (nominal)
3.4 ohms (minimum)

Filter Network Three-way, high-order acoustic response
@ 400 Hz and 2.3 kHz

Frequency Range -3 dB from 70 Hz to 45 kHz

In-Room Response ±0.5 dB from 75 Hz to 18 kHz
Relative-to-Target Response

Listening Window Response ±1.0 dB from 72 Hz to 20 kHz

Low-Frequency Extension -10 dB at 48 Hz
-6 dB at 60 Hz
-3 dB at 70 Hz

Dimensions & Weight:

Loudspeaker Height 24.2 inches (615 mm)
Width 12 inches (305 mm)
Depth 5.4 inches (137 mm)

On Floor Pedestal Height 46 inches (117 cm)

Shipping Weight 38 pounds (17.2 kg)

ULTIMA²







Revel® and the Revel logo are registered trademarks of Harman International Industries, Incorporated.

Not responsible for typographic errors.

Part # 072-20222 Rev. 1 10/07

3 Oak Park, Bedford, MA 01730-1413 USA
Tel: 781-280-0300 | Fax: 781-280-0490
www.revelspeakers.com

 Harman International