

PRODUCT RANGE

Atacama

Multi-Media Furniture Specialist



Evoque Eco 44 - 16
Design Edition

WHAT HI-FI?
SOUND AND VISION
★★★★★
March 2013
Elite Eco 12.0

Evoque Eco 24 - 16
Design Edition



Elite Eco 6.0



Elara 3 - 600 CM
Satin black / Medium Finish Bamboo



WHAT HI-FI?
SOUND AND VISION



April 2012 **Erís Eco 5.0**

WHAT HI-FI?
SOUND AND VISION
WHATIFI.COM
AWARDS 2013
ACCESSORIES
BEST EQUIPMENT SUPPORT
ATACAMA ERIS ECO 5.0

WHAT HI-FI?
SOUND AND VISION
WHATIFI.COM
AWARDS 2012
ACCESSORIES
BEST EQUIPMENT SUPPORT
ATACAMA ERIS ECO 5.0



UK Made



WHAT HI-FI?
SOUND AND VISION



May 2011

A.R.C. Glass

"A worthy upgrade... adding verve and insight"
What HiFi? Sound & Vision Magazine

Equinox Range



Moseco 6 Speaker Stands

WHAT HI-FI?
SOUND AND VISION



DUO series SPEAKER STANDS - February 2013
"we heard plenty of detail, clarity and transparency to treble - and there's tight base too"
WHAT HI-FI? SOUND AND VISION MAGAZINE

techradar.com
Deep into technology

DUO series SPEAKER STANDS - April 2011
"we were particularly struck by the neutrality and homogeneity of the tonal balance from upper bass upwards"
Techradar.com



UK Made

Issue 2
2014



TECHNICAL SPECIFICATIONS

ERIS **ECO** 5.0 HiFi SUPPORT COLOUR OPTIONS

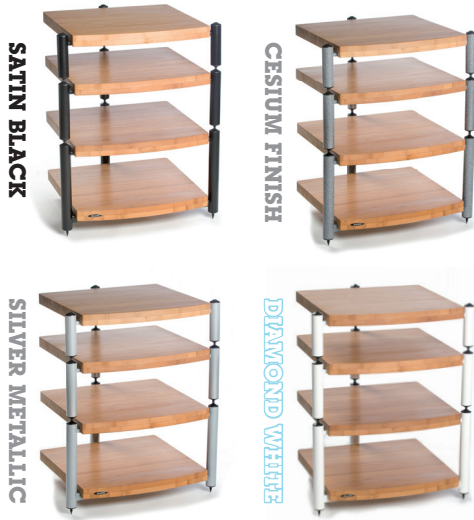

ELITE ECO 6.0 & 12.0



ERIS ECO 5.0 & SPECIAL EDITION



Weight capacity 20kg per level dependent on overall storage requirement.
Maximum number of modules = Base + 3 Shelves

BAMBOO COLOUR SWATCH



Please note—Bamboo is a natural material so colour, texture, grain and age may give a variable appearance to each module.

ATACAMA EVOQUE ECO 2416 & 4416

Weight capacity 30kg (66 lbs.) per level dependent on overall storage requirement.
Maximum overall height not to exceed 1255mm (50").
EVOQUE ECO 4416 DESIGN EDITION WIDTH IN BRACKETS.

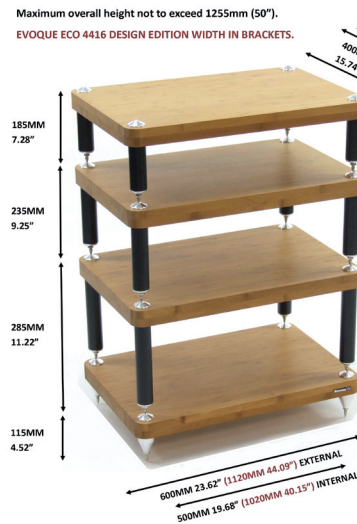

ATACAMA EVOQUE ECO 60-40 & ECO 1100 - 40

Weight capacity 30kg per level dependent on overall storage requirement.
Maximum overall height not to exceed 1255mm.
CUSTOM WIDTH AND DEPTH OPTIONS AVAILABLE (COST OPTION) – SEE ATACAMA WEBSITE FOR DETAILS

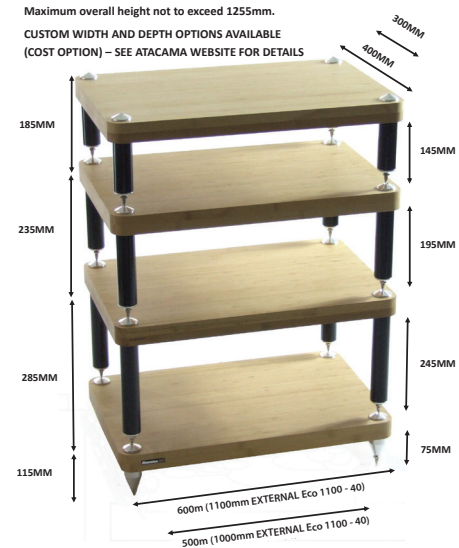

SPECIFICATIONS

EQUINOX AV & AVI TS/TL SE & ECO

- Total shared load capacity 100kgs
- Maximum load capacity per shelf 75kgs
- Total shared load capacity with optional shelf 125kgs

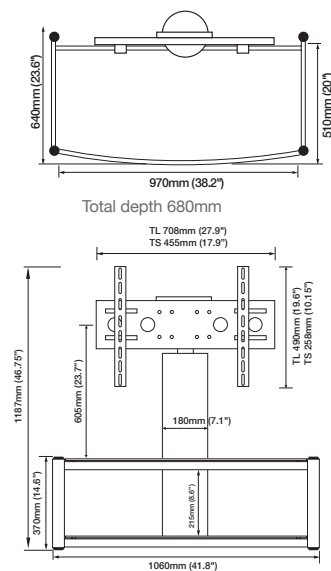
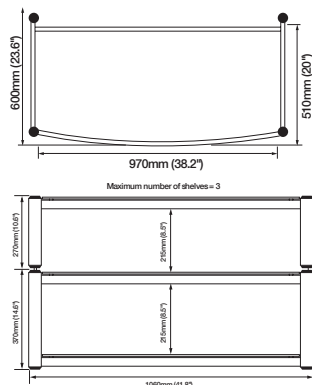

ELARA 3 - 600 HiFi & CM

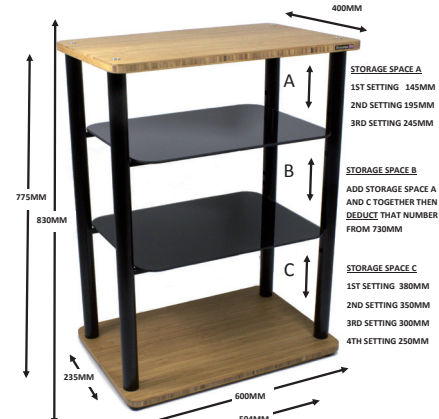

GLASS SHELF DIMENSIONS
500MM WIDTH
375MM DEPTH
6MM THICKNESS

WEIGHT CAPACITY
GLASS SHELVES (PER SHELF) 25KG
UPPER BAMBOO SHELF 25KG
LOWER BAMBOO SHELF 30KG
MAXIMUM TOTAL CAPACITY 75KG

TECHNICAL SPECIFICATIONS

DUO SERIES

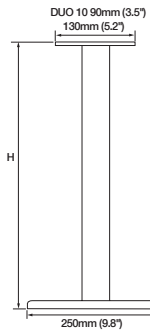
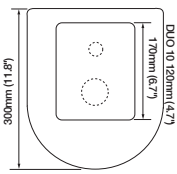

Model	Height 'H'
Duo 6	600mm (23.6")
Duo 7	700mm (27.6")
Duo 10	1000mm (39.4")

The height of each model excluding spikes.

NEXUS SERIES

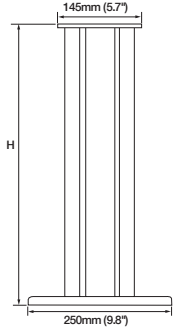
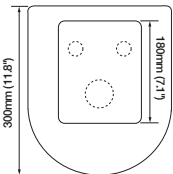

Model	Height 'H'
Nexus 5	500mm (19.7")
Nexus 6	600mm (23.6")
Nexus 7	700mm (27.6")
Nexus 10	1000mm (39.4")

The height of each model excluding spikes.

MOSECO SERIES

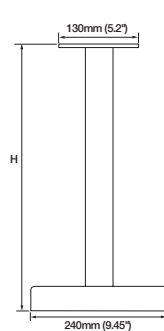
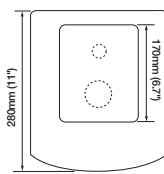

Model	Height 'H'
Moseco 5	500mm (19.7")
Moseco 6	600mm (23.6")
Moseco 7	700mm (27.6")
Moseco 10	1000mm (39.4")

The height of each model excluding spikes.

HMS 1.1 SERIES

3 height options of 500mm, 600mm and 700mm.

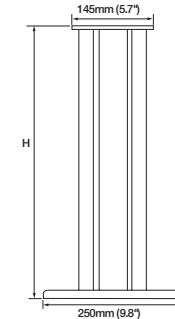
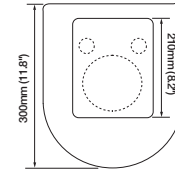

HMS 2.1

1 height option of 600mm

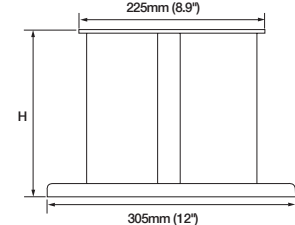
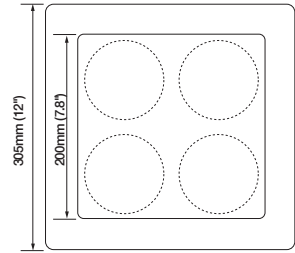

SL SERIES

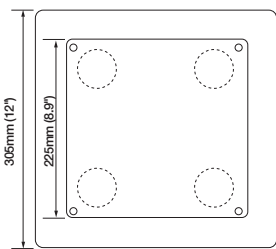

Model	Height 'H'
SL200	200mm (7.9")
SL300	300mm (11.8")
SL400	400mm (15.8")
SL500	500mm (19.7")
SL600	600mm (23.6")
SL700	700mm (27.6")
SL1000	1000mm (39.4")

The height of each model excluding spikes.

Custom sized top plates are available upon request.

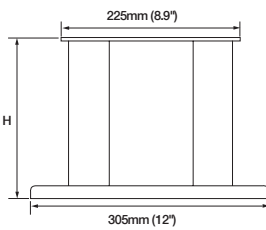

EQUINOX HiFi RS + RS CELEBRATION

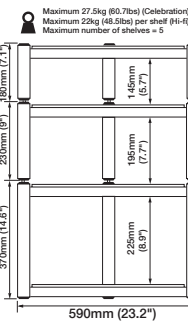
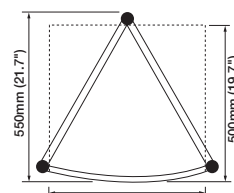

Maximum 27.5kg (60.7lbs) (Celebration)
Maximum 22kg (48.5lbs) per shelf (Hi-Fi)
Maximum number of shelves = 5

EQUINOX COLOUR SWATCHES

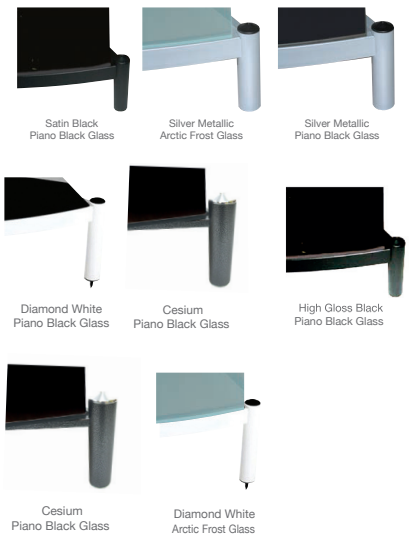

A.R.C. Glass available for Equinox HiFi & Celebration models in Piano Black only
Cesium paint finish available on selected products

CC SERIES

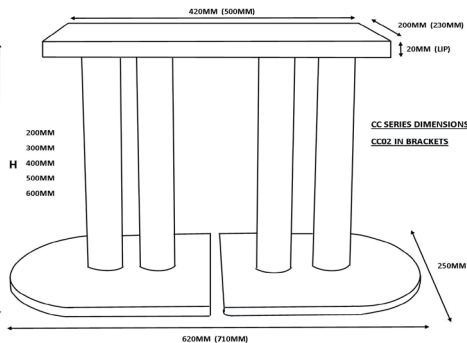

CC SERIES DIMENSIONS
CC02 IN BRACKETS

ATACAMA HD-S & HD-L Floor Spike Shoes

Atacama High Density spike shoes are made of a copper/zinc alloy construction and features an indentation on the upper surface to locate the spike and on its lower surface, a non slip E.P.D.M. elastomer membrane designed to protect delicate floor coverings and aid sound dampening. Each spike shoe has a diameter of 20mm (HD-S) and 25mm (HD-L), making the HD-S best suited to small and medium sized speaker stands, HD-L suitable for most large speaker stands and HiFi rack applications with an overall maximum weight spread over all four shoes of 70kg (HD-S), 125kg (HD-L). They are available in a choice of two colours, Satin Black or Nickel Silver.



ATABITES SMD-Z 7.5HD

PLEASE NOTE- Atabites are supplied by weight, not volume. (7.5 kg tubs). Some settling of contents may occur in transit. Here is the maximum Approximate weight of Atabites that can be used in each pair of speaker stands:-
Moseco 5=7kg Duo/Moseco 6=10.4kg Duo/Moseco 7=12.2kg Duo 10=N/A Moseco 10=15kg
Nexus 6i=8.2kg Nexus 7i=12.2kg Nexus10i=21kg
SL200=7.2kg SL300=15.2kg SL400=24kg SL500=32.8kg
SL600=41.6kg SL700=48.8kg SL1000=68kg
HMS1.1 500mm=34kg HMS1.1 600mm=41.8kg
HMS1.1 700mm=55.4kg HMS2.1=84kg.
Sonic results will depend on speaker stand positioning, type of speaker, room size, type of electronics and cabling, listening position and personal taste. However, as a guide, filling the stands approximately two thirds full generally gives the best results.

EQUINOX RANGE



Atacama offer a full 2 years guarantee on all Atacama products. Giving you peace of mind, and assurance of quality.

Sambell Engineering Ltd
Winston Avenue
Croft, Leicester LE9 3GQ
Tel: 01455 283251
Fax: 01455 283908
Email: post@atacama-audio.co.uk
Web: www.atacama-audio.co.uk

Atacama
Multi-Media Furniture Specialist